

Model: UCFL214

Shaft Dia.

d (in.):	
d (mm):	70

Dimensions(mm)(inch)

H:	265
J:	216
L:	160
A2:	31
A1:	22
A:	54
N:	23
E:	75.4
S:	30.2

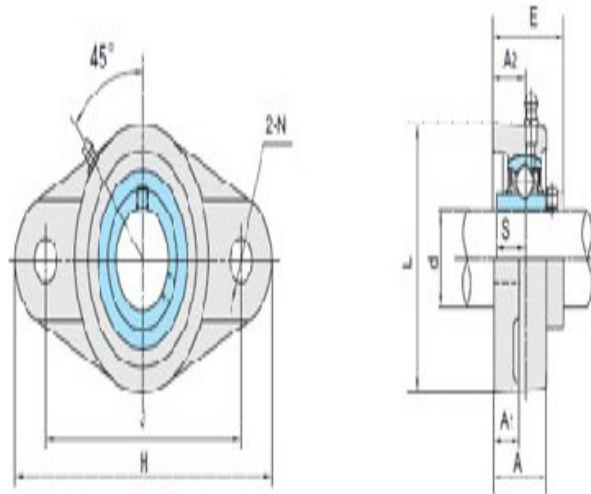

UCFL2

Unit No.

Unit No.:	UCFL214
-----------	---------

Bolt Used (mm) (in.)

Bolt Used (mm) (in.):	M20
-----------------------	-----

Bearing No.

Bearing No.:	UC214
--------------	-------

Housing No.

Housing No.:	FL214
--------------	-------

Weight(kg)(lb)

Weight(kg)(lb):	5.60
-----------------	------