

Model: UCFL212-36

Shaft Dia.

d (in.): 21/4

d (mm):

Dimensions(mm)(inch)

H: 9.8425

J: 7.9528

L: 5.5118

A2: 1.1417

A1: 0.7087

A: 1.8898

N: 0.9055

E: 2.7047

S: 1.0000

Unit No.

Unit No.: UCFL212-36

Bolt Used (mm) (in.)

Bolt Used (mm) (in.): 3/4

Bearing No.

Bearing No.: UC212-36

Housing No.

Housing No.:

Weight(kg)(lb)

Weight(kg)(lb):

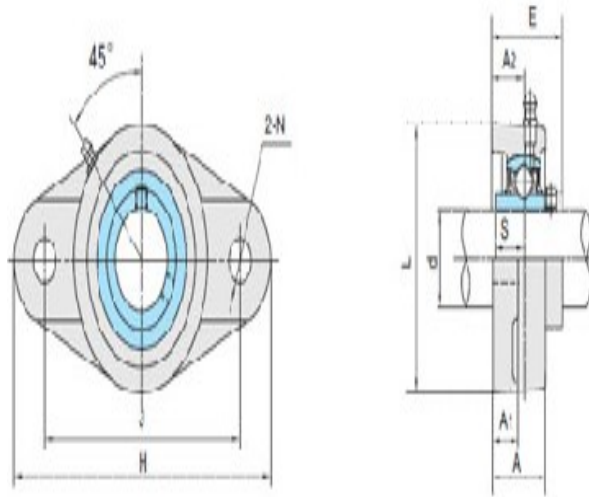

UCFL2