

Model: UCFL212

Shaft Dia.

d (in.):	
d (mm):	60

Dimensions(mm)(inch)

H:	250
J:	202
L:	140
A2:	29
A1:	18
A:	48
N:	23
E:	68.7
S:	25.4

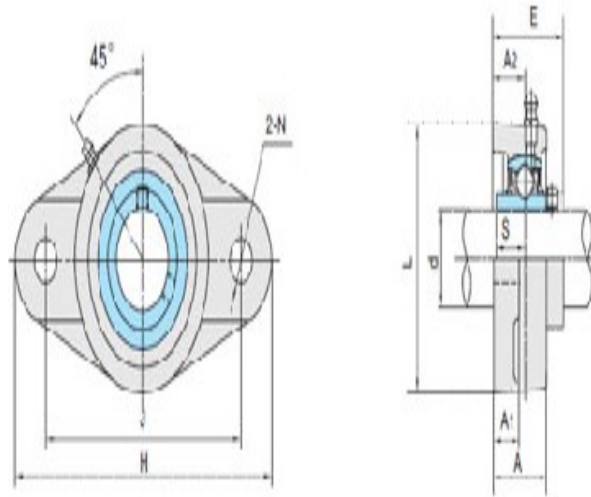
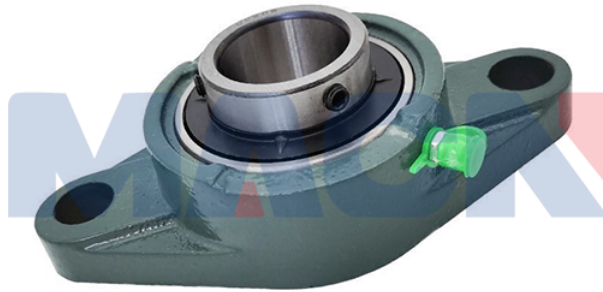

UCFL2

Unit No.

Unit No.:	UCFL212
-----------	---------

Bolt Used (mm) (in.)

Bolt Used (mm) (in.):	M20
-----------------------	-----

Bearing No.

Bearing No.:	UC212
--------------	-------

Housing No.

Housing No.:	FL212
--------------	-------

Weight(kg)(lb)

Weight(kg)(lb):	3.99
-----------------	------