

Model: UCFL210

Shaft Dia.

d (in.):	
d (mm):	50

Dimensions(mm)(inch)

H:	197
J:	157
L:	115
A2:	22
A1:	16
A:	40
N:	19
E:	54.6
S:	19.0

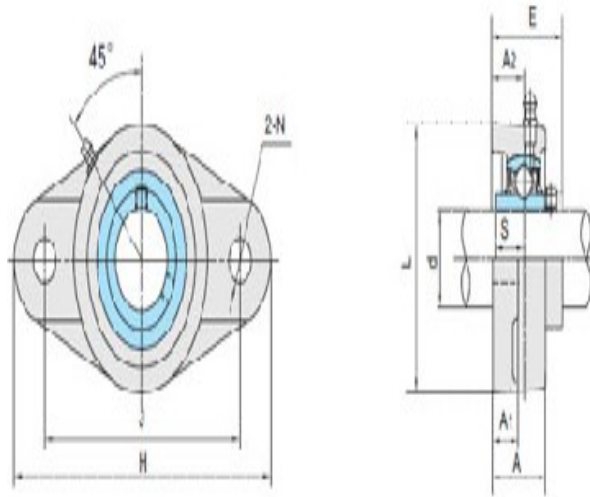
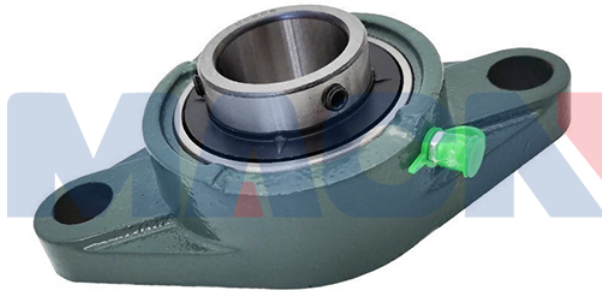

UCFL2

Unit No.

Unit No.:	UCFL210
-----------	---------

Bolt Used (mm) (in.)

Bolt Used (mm) (in.):	M16
-----------------------	-----

Bearing No.

Bearing No.:	UC210
--------------	-------

Housing No.

Housing No.:	FL210
--------------	-------

Weight(kg)(lb)

Weight(kg)(lb):	2.15
-----------------	------