

**Model: UCFL209**

Shaft Dia.

d (in.):	
d (mm):	45

Dimensions(mm)(inch)

H:	188
J:	148
L:	108
A2:	22
A1:	16
A:	38
N:	19
E:	52.2
S:	19.0

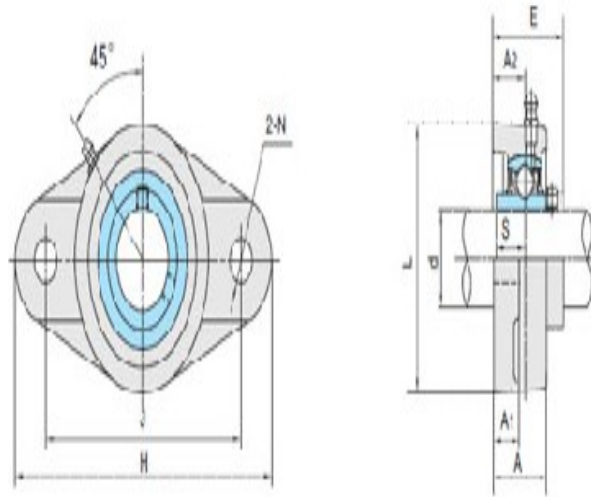
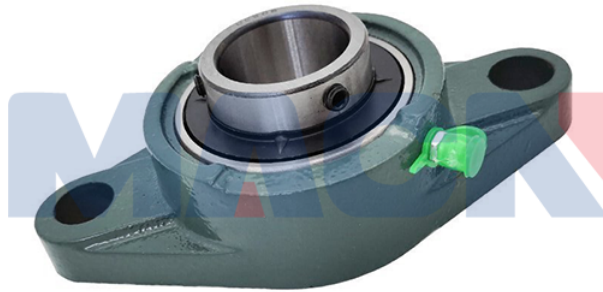

UCFL2

Unit No.

Unit No.:	UCFL209
-----------	---------

Bolt Used (mm) (in.)

Bolt Used (mm) (in.):	M16
-----------------------	-----

Bearing No.

Bearing No.:	UC209
--------------	-------

Housing No.

Housing No.:	FL209
--------------	-------

Weight(kg)(lb)

Weight(kg)(lb):	1.84
-----------------	------