

Model: UCFL208

Shaft Dia.

d (in.):	
d (mm):	40

Dimensions(mm)(inch)

H:	175
J:	144
L:	100
A2:	21
A1:	15
A:	36
N:	16
E:	51.2
S:	19.0

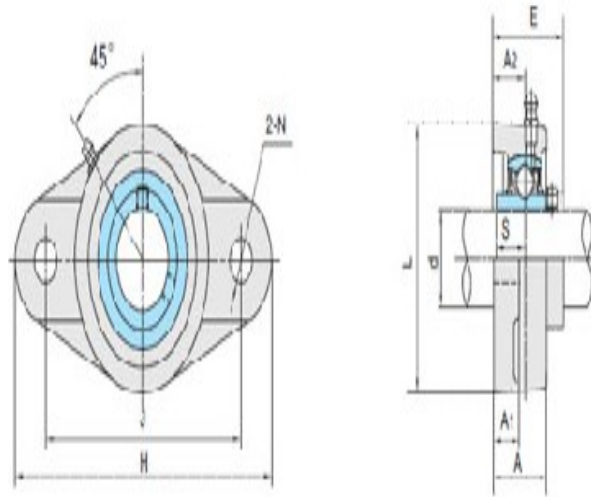
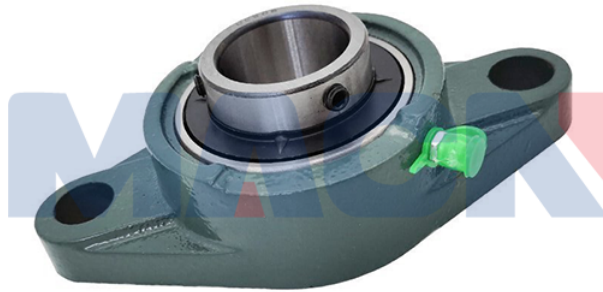

UCFL2

Unit No.

Unit No.:	UCFL208
-----------	---------

Bolt Used (mm) (in.)

Bolt Used (mm) (in.):	M14
-----------------------	-----

Bearing No.

Bearing No.:	UC208
--------------	-------

Housing No.

Housing No.:	FL208
--------------	-------

Weight(kg)(lb)

Weight(kg)(lb):	1.59
-----------------	------