

**Model: UCFL207**

Shaft Dia.

d (in.):	
d (mm):	35

Dimensions(mm)(inch)

H:	161
J:	130
L:	90
A2:	19
A1:	15
A:	34
N:	16
E:	44.4
S:	17.5

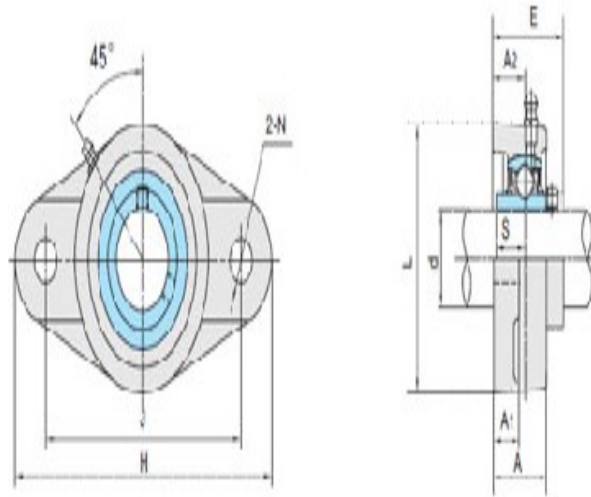
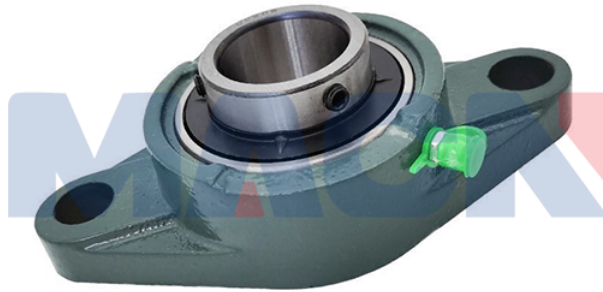

UCFL2

Unit No.

Unit No.:	UCFL207
-----------	---------

Bolt Used (mm) (in.)

Bolt Used (mm) (in.):	M14
-----------------------	-----

Bearing No.

Bearing No.:	UC207
--------------	-------

Housing No.

Housing No.:	FL207
--------------	-------

Weight(kg)(lb)

Weight(kg)(lb):	1.20
-----------------	------