

Model: UCFL206-18

Shaft Dia.

d (in.): 11/8

d (mm):

Dimensions(mm)(inch)

H: 5.8268

J: 4.6063

L: 3.1496

A2: 0.7087

A1: 0.5118

A: 1.2205

N: 0.6299

E: 1.5287

S: 0.6260

Unit No.

Unit No.: UCFL206-18

Bolt Used (mm) (in.)

Bolt Used (mm) (in.): 9/16

Bearing No.

Bearing No.: UC206-18

Housing No.

Housing No.:

Weight(kg)(lb)

Weight(kg)(lb): 2.0

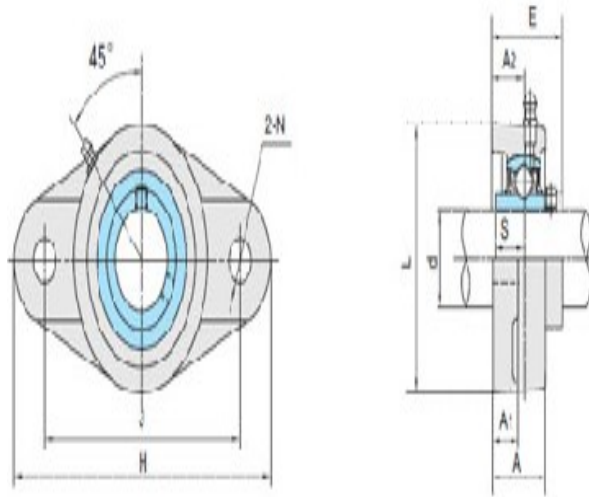

UCFL2