

Model: UCFL205

Shaft Dia.

d (in.):	
d (mm):	25

Dimensions(mm)(inch)

H:	130
J:	99
L:	68
A2:	16
A1:	13
A:	27
N:	16
E:	35.8
S:	14.3

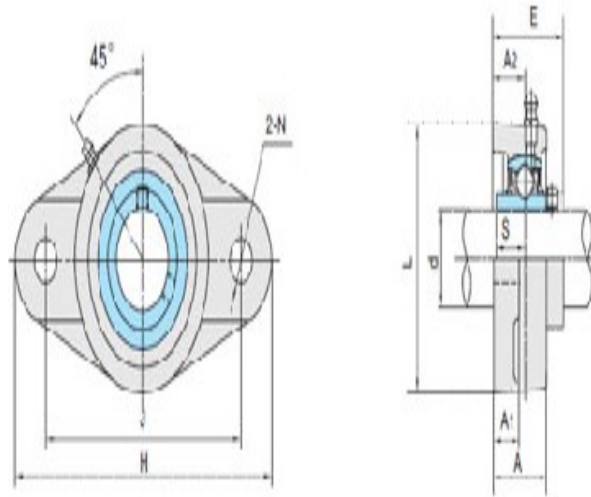
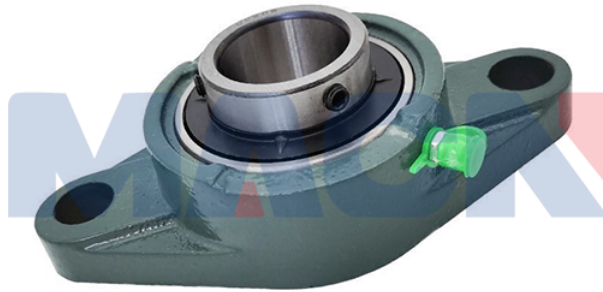

UCFL2

Unit No.

Unit No.:	UCFL205
-----------	---------

Bolt Used (mm) (in.)

Bolt Used (mm) (in.):	M14
-----------------------	-----

Bearing No.

Bearing No.:	UC205
--------------	-------

Housing No.

Housing No.:	FL205
--------------	-------

Weight(kg)(lb)

Weight(kg)(lb):	0.64
-----------------	------