

Model: UCFL204-12

Shaft Dia.

d (in.): 3/4

d (mm):

Dimensions(mm)(inch)

H: 4.4488

J: 3.5433

L: 2.3622

A2: 0.5906

A1: 0.4331

A: 1.0039

N: 0.4724

E: 1.3110

S: 0.5000

Unit No.

Unit No.: UCFL204-12

Bolt Used (mm) (in.)

Bolt Used (mm) (in.): 3/8

Bearing No.

Bearing No.: UC204-12

Housing No.

Housing No.:

Weight(kg)(lb)

Weight(kg)(lb): 1.1

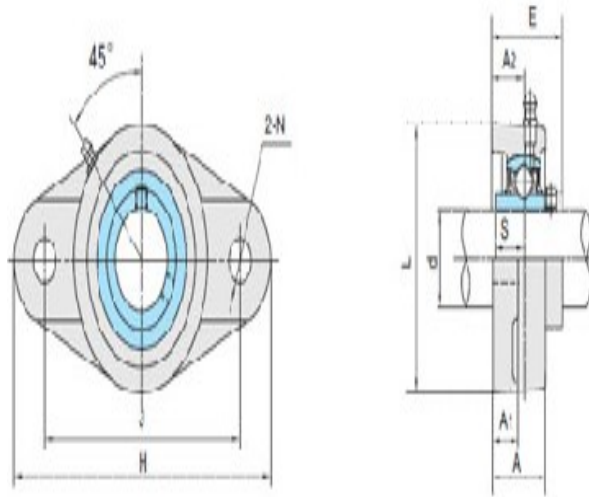

UCFL2