

**Model: UCFL203-11**

Shaft Dia.

d (in.):	11/16
d (mm):	

Dimensions(mm)(inch)

H:	4.4488
J:	3.5433
L:	2.3622
A2:	0.5906
A1:	0.4331
A:	1.0039
N:	0.4724
E:	1.3110
S:	0.5000

Unit No.

Unit No.:	UCFL203-11
-----------	------------

Bolt Used (mm) (in.)

Bolt Used (mm) (in.):	3/8
-----------------------	-----

Bearing No.

Bearing No.:	UC203-11
--------------	----------

Housing No.

Housing No.:	
--------------	--

Weight(kg)(lb)

Weight(kg)(lb):	1.2
-----------------	-----

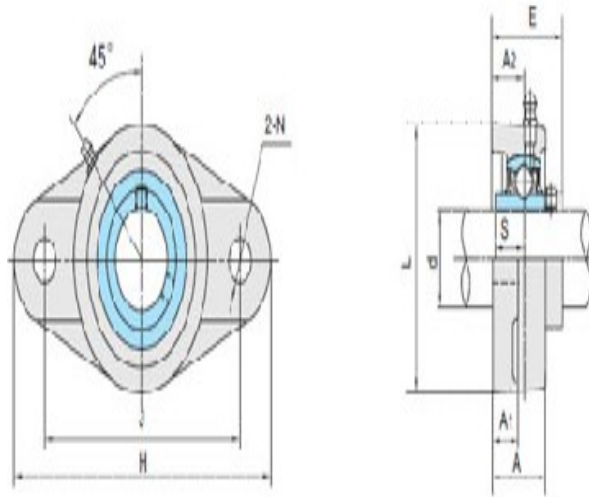

UCFL2