

Model: UCFL312-36

Shaft Dia.

d (in.): 21/4

d (mm):

Dimensions(mm)(inch)

H: 10.630

J: 8.3464

L: 6.2992

A2: 1.2992

A1: 0.8661

A: 2.2047

N: 1.2205

E: 3.0709

S: 1.0236

Unit No.

Unit No.: UCFL312-36

Bolt Used (mm) (in.)

Bolt Used (mm) (in.): 1

Bearing No.

Bearing No.: UC312-36

Housing No.

Housing No.:

Weight(kg)(lb)

Weight(kg)(lb):

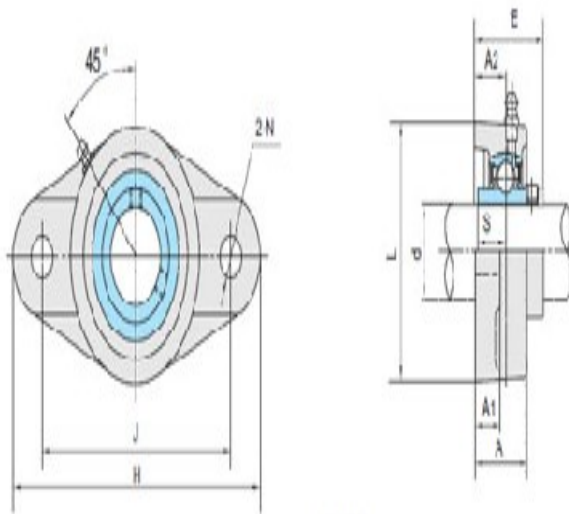

UCFL3