

Model: UCFL310-32

Shaft Dia.

d (in.):	2
d (mm):	

Dimensions(mm)(inch)

H:	9.4488
J:	7.3622
L:	5.5118
A2:	1.1024
A1:	0.7480
A:	1.8898
N:	0.9842
E:	2.6378
S:	0.8661

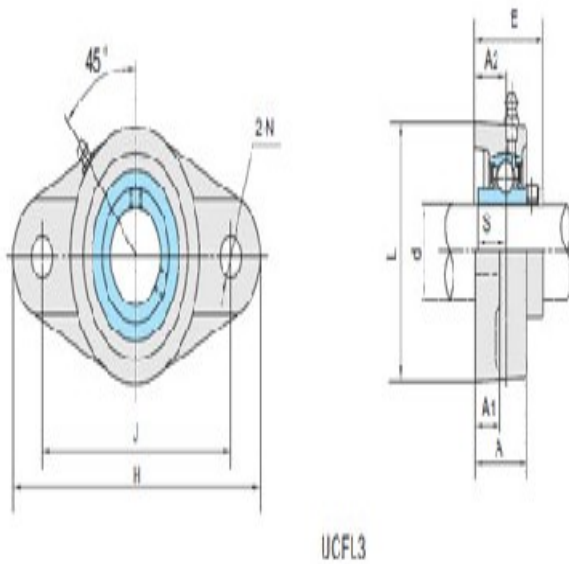

Unit No.

Unit No.:	UCFL310-32
-----------	------------

Bolt Used (mm) (in.)

Bolt Used (mm) (in.):	7/8
-----------------------	-----

Bearing No.

Bearing No.:	UC310-32
--------------	----------

Housing No.

Housing No.:	
--------------	--

Weight(kg)(lb)

Weight(kg)(lb):	
-----------------	--