

Model: UCFL309-28

Shaft Dia.

d (in.): 13/4

d (mm):

Dimensions(mm)(inch)

H: 9.0551

J: 6.9685

L: 4.9212

A2: 0.9842

A1: 0.7087

A: 1.7323

N: 0.9842

E: 2.3622

S: 0.8661

Unit No.

Unit No.: UCFL309-28

Bolt Used (mm) (in.)

Bolt Used (mm) (in.): 7/8

Bearing No.

Bearing No.: UC309-28

Housing No.

Housing No.:

Weight(kg)(lb)

Weight(kg)(lb):

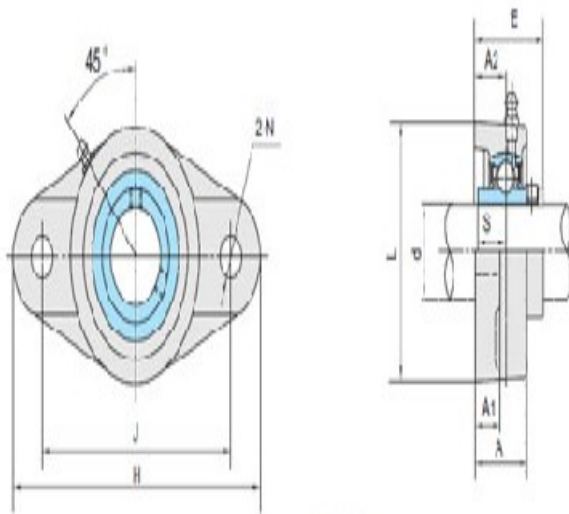
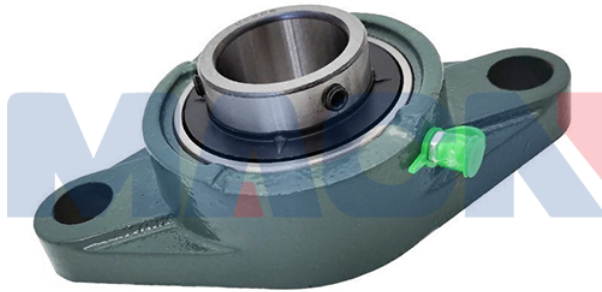

UCFL3