

Model: UCFL308

Shaft Dia.

d (in.):	
d (mm):	40

Dimensions(mm)(inch)

H:	200
J:	158
L:	112
A2:	23
A1:	17
A:	40
N:	23
E:	56
S:	19

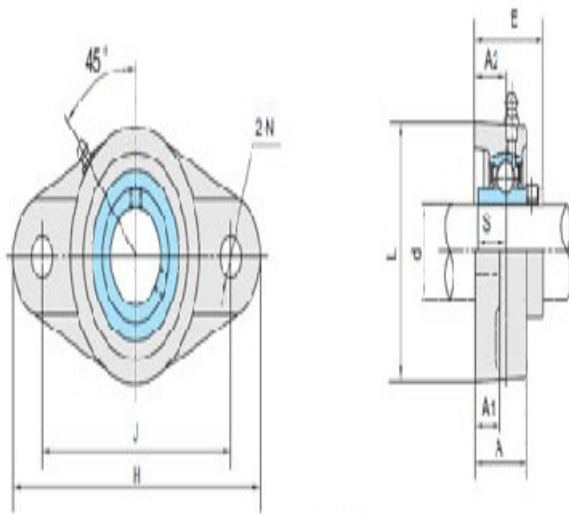

UCFL3

Unit No.

Unit No.:	UCFL308
-----------	---------

Bolt Used (mm) (in.)

Bolt Used (mm) (in.):	M20
-----------------------	-----

Bearing No.

Bearing No.:	UC308
--------------	-------

Housing No.

Housing No.:	FL308
--------------	-------

Weight(kg)(lb)

Weight(kg)(lb):	2.50
-----------------	------