

**Model: UCFL307-22**

Shaft Dia.

d (in.): 13/8

d (mm):

Dimensions(mm)(inch)

H: 7.2835

J: 5.5512

L: 3.9370

A2: 0.7874

A1: 0.6299

A: 1.4173

N: 0.9055

E: 1.9291

S: 0.7480

Unit No.

Unit No.: UCFL307-22

Bolt Used (mm) (in.)

Bolt Used (mm) (in.): 3/4

Bearing No.

Bearing No.: UC307-22

Housing No.

Housing No.:

Weight(kg)(lb)

Weight(kg)(lb):

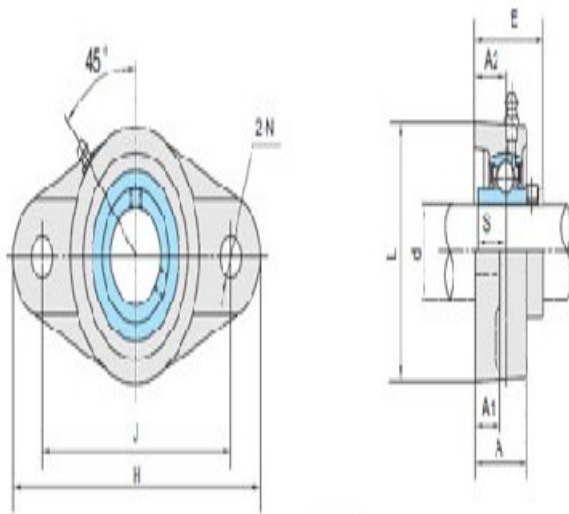
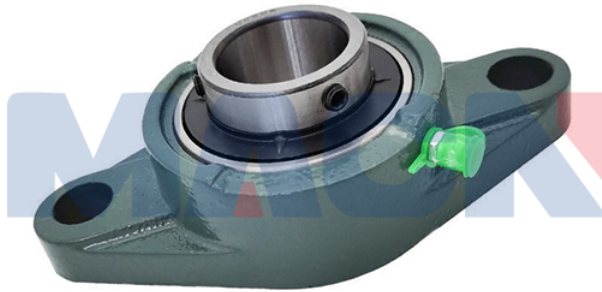

UCFL3