

**Model: UCFL306-19**

Shaft Dia.

d (in.): 13/16

d (mm):

Dimensions(mm)(inch)

H: 7.0866

J: 5.2756

L: 3.5433

A2: 0.7087

A1: 0.5906

A: 1.2598

N: 0.9055

E: 1.7323

S: 0.6693

Unit No.

Unit No.: UCFL306-19

Bolt Used (mm) (in.)

Bolt Used (mm) (in.): 3/4

Bearing No.

Bearing No.: UC306-19

Housing No.

Housing No.:

Weight(kg)(lb)

Weight(kg)(lb):

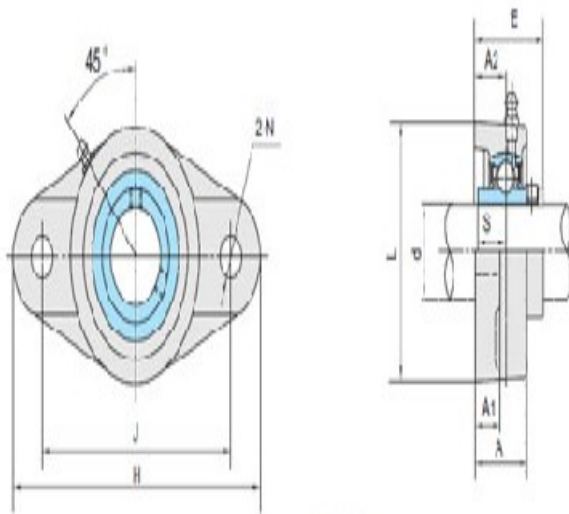
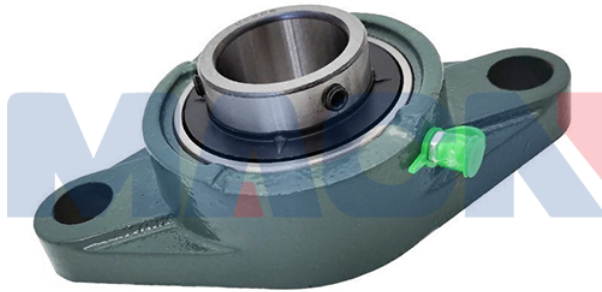

UCFL3