

Model: UCFL306

Shaft Dia.

d (in.):	
d (mm):	30

Dimensions(mm)(inch)

H:	180
J:	134
L:	90
A2:	18
A1:	15
A:	32
N:	23
E:	44
S:	17

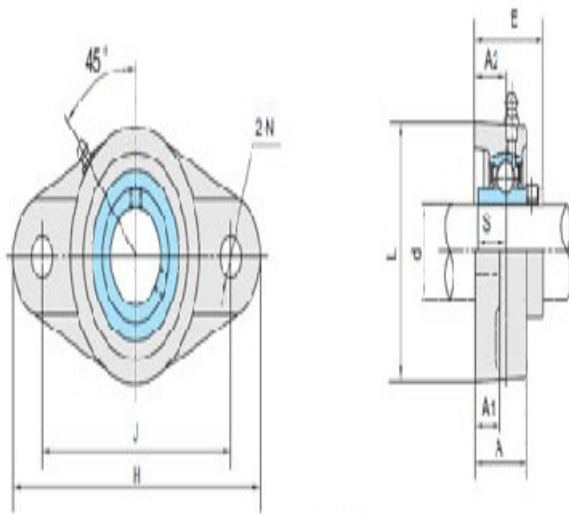
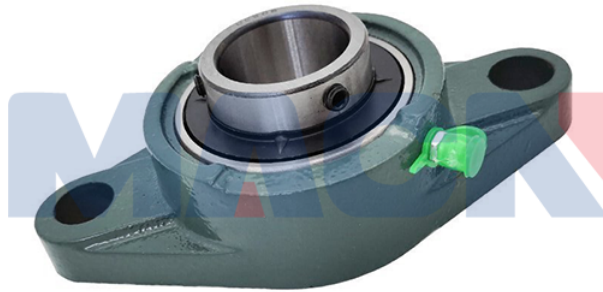

UCFL3

Unit No.

Unit No.:	UCFL306
-----------	---------

Bolt Used (mm) (in.)

Bolt Used (mm) (in.):	M20
-----------------------	-----

Bearing No.

Bearing No.:	UC306
--------------	-------

Housing No.

Housing No.:	FL306
--------------	-------

Weight(kg)(lb)

Weight(kg)(lb):	1.66
-----------------	------