

Model: UCFL305-14

Shaft Dia.

d (in.): 7/8

d (mm):

Dimensions(mm)(inch)

H: 5.9055

J: 4.4488

L: 3.1496

A2: 0.6299

A1: 0.5118

A: 1.1417

N: 0.7480

E: 1.5354

S: 0.5906

Unit No.

Unit No.: UCFL305-14

Bolt Used (mm) (in.)

Bolt Used (mm) (in.): 5/8

Bearing No.

Bearing No.: UC305-14

Housing No.

Housing No.:

Weight(kg)(lb)

Weight(kg)(lb):

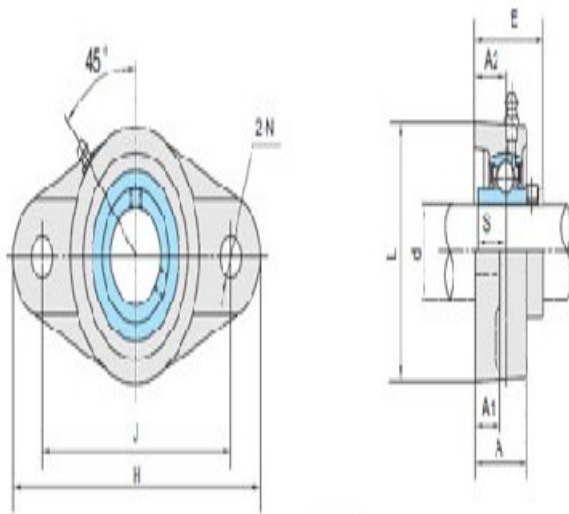
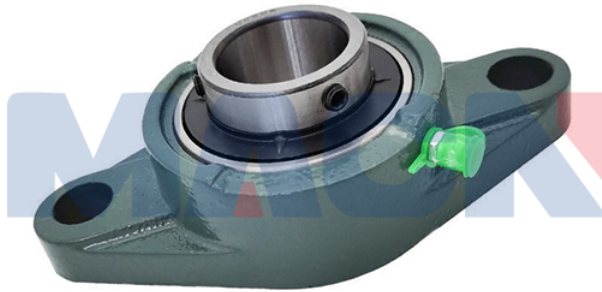

UCFL3