

Model: UKFL213+H2313

Shaft Dia.

d (in.):	
d (mm):	60

Dimensions(mm)(inch)

H:	258
J:	210
L:	155
A2:	30
A1:	22
A:	50
N:	23
E:	63.0
S1:	33.0

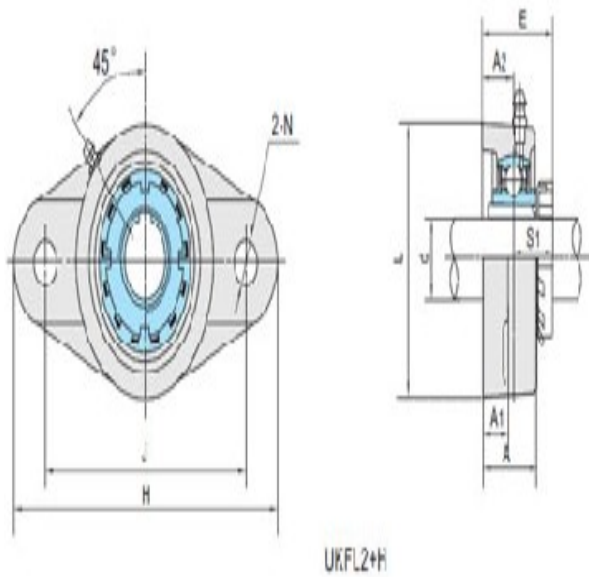
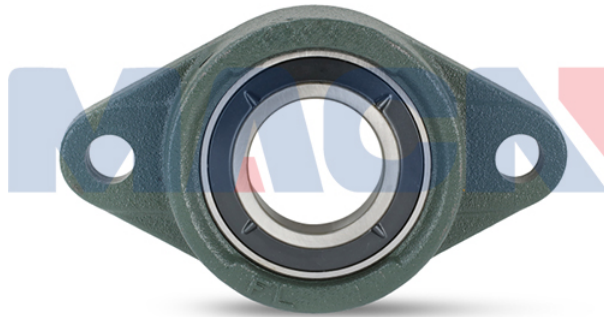

Unit No.

Unit No.:	UKFL213+H2313
	3

Bolt Used (mm) (in.)

Bolt Used (mm)	M20
(in.):	

Bearing No.

Bearing No.:	UK213
--------------	-------

Housing No.

Housing No.:	FL213
--------------	-------

Adapter Used.

Adapter Used.:	H2313
----------------	-------

Weight(kg)(lb)

Weight(kg)(lb):	5.05
-----------------	------