

Model: UKFL212+H2312

Shaft Dia.

d (in.):	
d (mm):	55

Dimensions(mm)(inch)

H:	250
J:	202
L:	140
A2:	29
A1:	18
A:	48
N:	23
E:	60.0
S1:	31.0

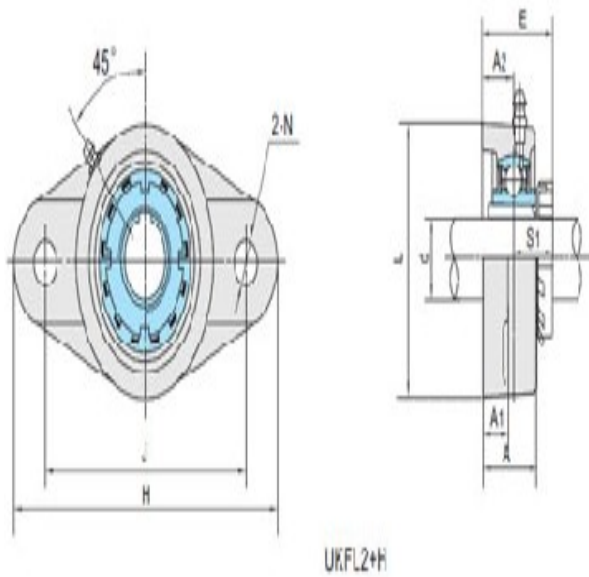
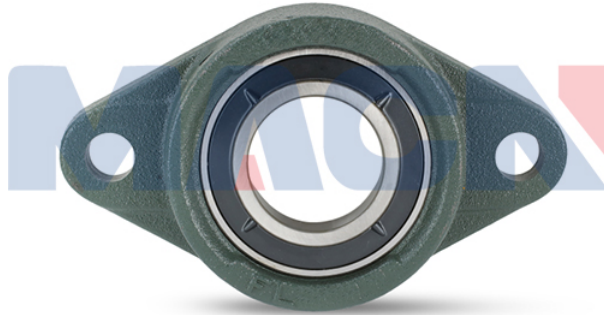

Unit No.

Unit No.:	UKFL212+H2312
	2

Bolt Used (mm) (in.)

Bolt Used (mm)	M20
(in.):	

Bearing No.

Bearing No.:	UK212
--------------	-------

Housing No.

Housing No.:	FL212
--------------	-------

Adapter Used.

Adapter Used.:	H2312
----------------	-------

Weight(kg)(lb)

Weight(kg)(lb):	4.02
-----------------	------