

**Model: UKFL206+HA2306**

Shaft Dia.

d (in.):	15/16
d (mm):	

Dimensions(mm)(inch)

H:	5.8268
J:	4.6063
L:	3.1496
A2:	0.7087
A1:	0.5118
A:	1.2205
N:	0.6299
E:	1.5354
S1:	0.8268

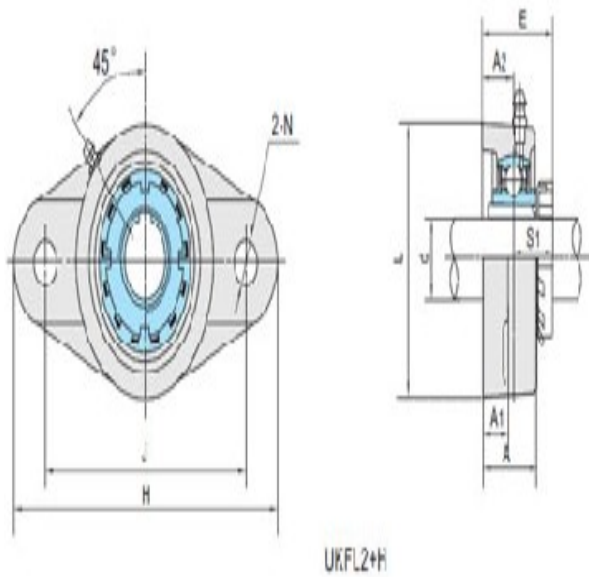
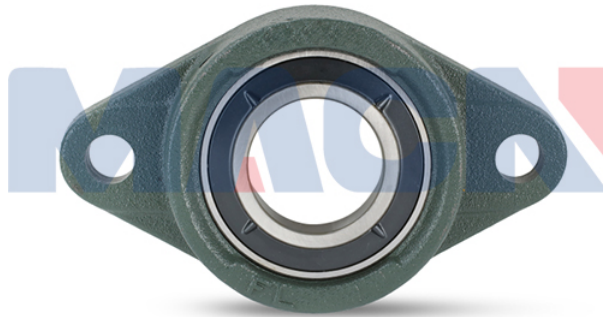

Unit No.

Unit No.:	UKFL206+HA2306
	6

Bolt Used (mm) (in.)

Bolt Used (mm)	
(in.):	9/16

Bearing No.

Bearing No.:

Housing No.

Housing No.:

Adapter Used.

Adapter Used.: HA2306

Weight(kg)(lb)

Weight(kg)(lb): 2.2