



Model: UCC310-31

Shaft Dia.

d (in.): 115/16

d (mm):

Dimensions(mm)(inch)

L: 5.5118

A: 1.5748

r: 0.1378

B: 2.4016

S: 0.8661

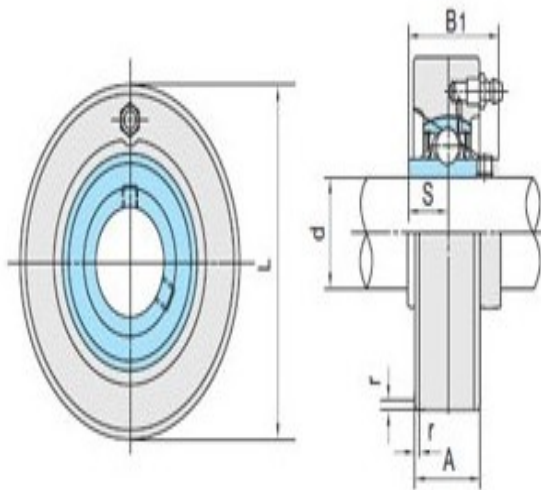

UCC2

Unit No.

Unit No.: UCC310-31

Bearing No.

Bearing No.: UC310-31

Housing No.

Housing No.:

Weight(kg)(lb)

Weight(kg)(lb): 7.4