



Model: UCC309-26

Shaft Dia.

d (in.): 15/8

d (mm):

Dimensions(mm)(inch)

L: 5.1181

A: 1.4961

r: 0.1378

B: 2.2441

S: 0.8661

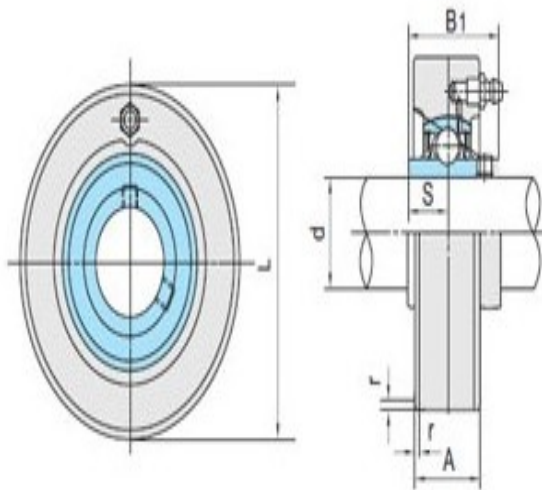

UCC2

Unit No.

Unit No.: UCC309-26

Bearing No.

Bearing No.: UC309-26

Housing No.

Housing No.:

Weight(kg)(lb)

Weight(kg)(lb):