



Model: UCC307-22

Shaft Dia.

d (in.): 13/8

d (mm):

Dimensions(mm)(inch)

L: 4.3307

A: 1.2598

r: 0.1181

B: 1.8898

S: 0.7480

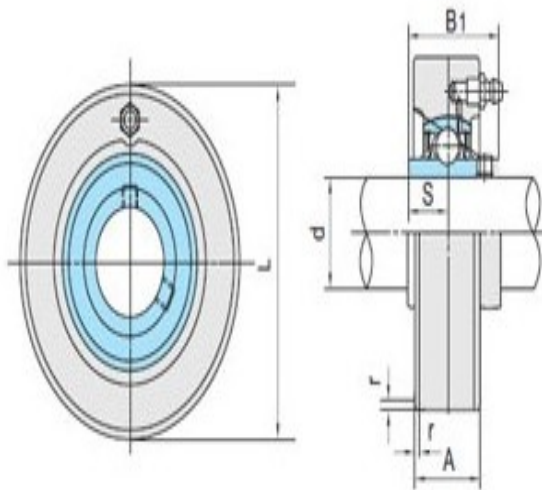

UCC2

Unit No.

Unit No.: UCC307-22

Bearing No.

Bearing No.: UC307-22

Housing No.

Housing No.:

Weight(kg)(lb)

Weight(kg)(lb):