

Model: UCC212-39

Shaft Dia.

d (in.): 23/8

d (mm):

Dimensions(mm)(inch)

L: 5.1181

A: 1.4961

r: 0.0984

B: 2.5630

S: 1.0000

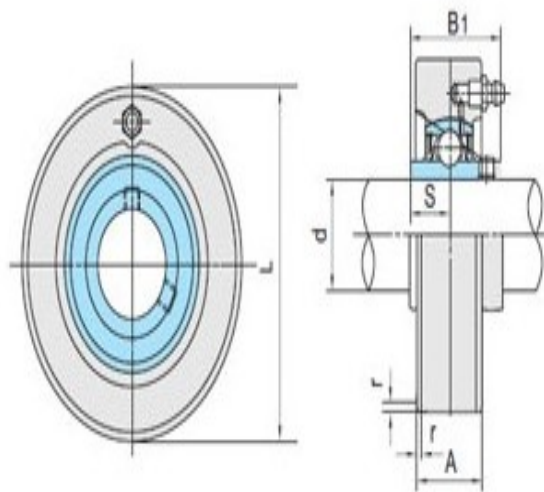

UCC2

Unit No.

Unit No.: UCC212-39

Bearing No.

Bearing No.: UC212-39

Housing No.

Housing No.:

Weight(kg)(lb)

Weight(kg)(lb):