



Model: UCC211-32

Shaft Dia.

d (in.):	2
d (mm):	

Dimensions(mm)(inch)

L:	4.9212
A:	1.3780
r:	0.0984
B:	2.1890
S:	0.8740

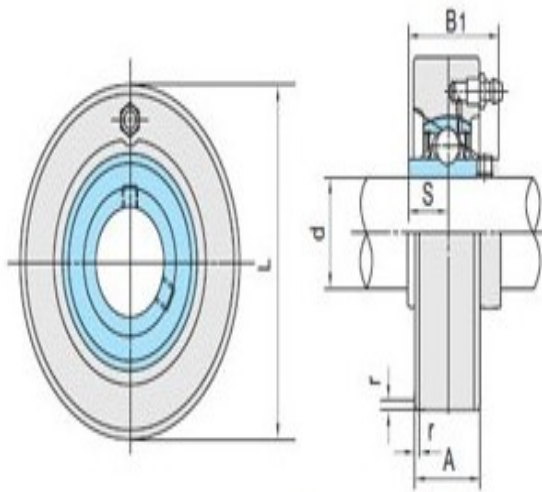

UCC2

Unit No.

Unit No.:	UCC211-32
-----------	-----------

Bearing No.

Bearing No.:	UC211-32
--------------	----------

Housing No.

Housing No.:	
--------------	--

Weight(kg)(lb)

Weight(kg)(lb):	
-----------------	--