

Model: UCC207-23

Shaft Dia.

d (in.):	17/16
d (mm):	

Dimensions(mm)(inch)

L:	3.5433
A:	1.1024
r:	0.0787
B:	1.6890
S:	0.6890

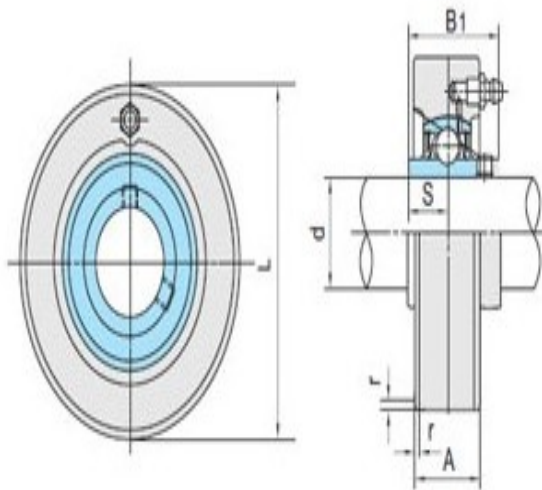

UCC2

Unit No.

Unit No.:	UCC207-23
-----------	-----------

Bearing No.

Bearing No.:	UC207-23
--------------	----------

Housing No.

Housing No.:	
--------------	--

Weight(kg)(lb)

Weight(kg)(lb):	
-----------------	--