



Model: UCC201-8

Shaft Dia.

d (in.): 1/2

d (mm):

Dimensions(mm)(inch)

L: 2.8346

A: 0.7874

r: 0.0787

B: 1.2205

S: 0.5000

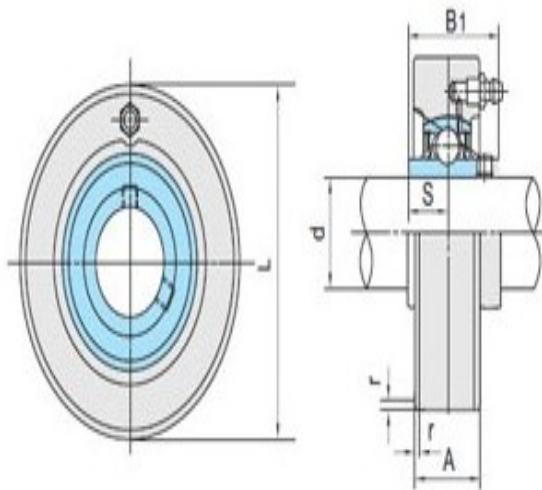

UCC2

Unit No.

Unit No.: UCC201-8

Bearing No.

Bearing No.: UC201-8

Housing No.

Housing No.:

Weight(kg)(lb)

Weight(kg)(lb): 1.2