



**Model: UCFB212-36**

Shaft Dia.

d (in.): 21/4

d (mm):

Dimensions(mm)(inch)

H2: 8.8189

L: 5.5118

P: 3.7008

H: 3.3071

J: 2.5984

T: 2.1654

H1: 2.5630

A2: 1.1417

A1: 0.7480

A: 1.8701

N: 0.5512

E: 2.7047

S: 1.0000

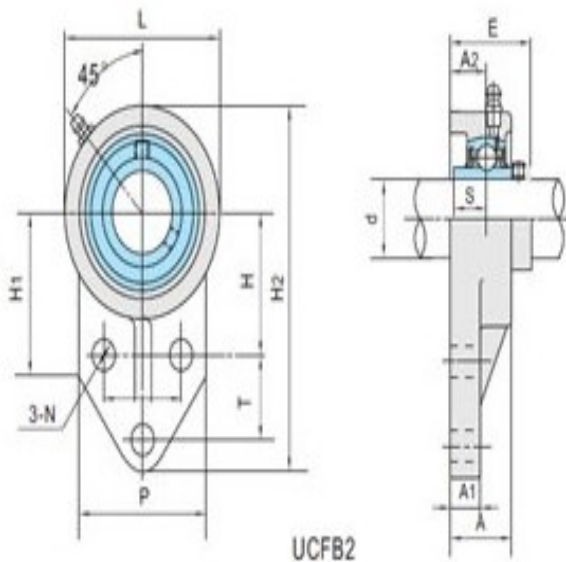

Unit No.

Unit No.: UCFB212-36

Bolt Used (mm) (in.)

Bolt Used (mm) (in.): 1/2

Bearing No.

Bearing No.: UC212-36

Housing No.

Housing No.:

Weight(kg)(lb)

Weight(kg)(lb):