



Model: SAPF202-9

Shaft Dia.

d (in.): 9/16

d (mm):

Dimensions(mm)(inch)

L: 3.1890

P: 2.5000

A1: 0.1575

N: 0.2795

A: 0.5512

B1: 1.1260

S: 0.2559

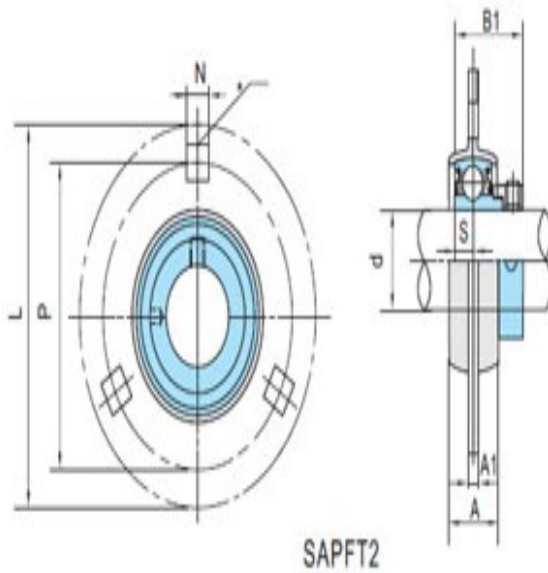

Unit No.

Unit No.: SAPF202-9

Bolt Used (mm) (in.)

Bolt Used (mm) (in.): 1/4

Bearing No.

Bearing No.: SA202-9F

Housing No.

Housing No.:

Weight(kg)(lb)

Weight(kg)(lb): 0.57