

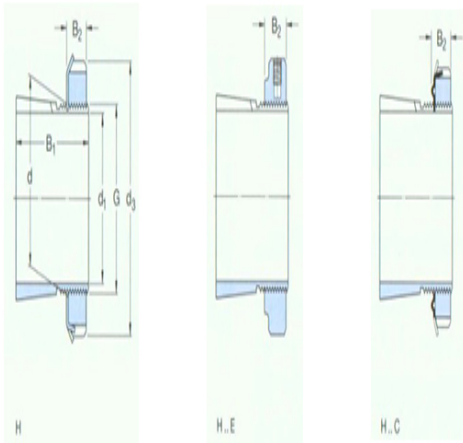

型号: H209

尺寸

d ₁ :	40
d:	45
d ₃ :	65
B ₁ :	33
B ₂ :	11
G:	M45×1.5
质量:	0.21



型号

带锁紧螺母和锁定装置的紧定套:	H209
锁紧螺母:	KM9
锁紧装置:	MB9
适用的液压螺母:	-