

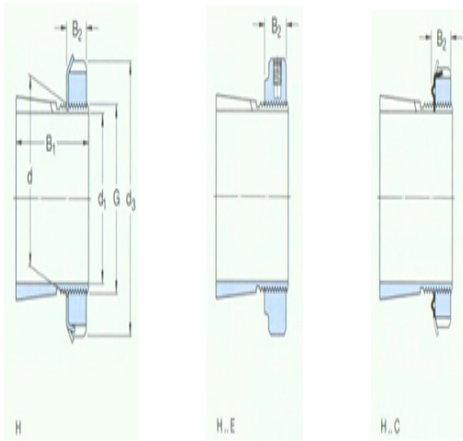

型号: H217

尺寸

d ₁ :	75
d:	85
d ₃ :	110
B ₁ :	50
B ₂ :	18
G:	M85×2
质量:	0.94



型号

带锁紧螺母和锁定装置的紧定套	H217
:	
锁紧螺母:	KM17
锁紧装置:	MB17
适用的液压螺母:	HMV17 E