

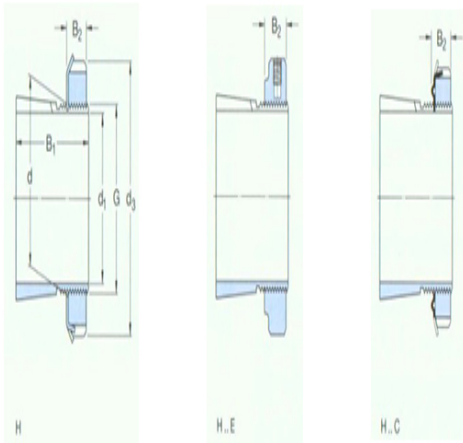

型号: KM8

尺寸

d ₁ :	35
d:	40
d ₃ :	58
B ₁ :	36
B ₂ :	10.5
G:	M40×1.5
质量:	0.17



型号

带锁紧螺母和锁定装置的紧定套:	H308C
锁紧螺母:	KM8
锁紧装置:	MB8C
适用的液压螺母:	-