

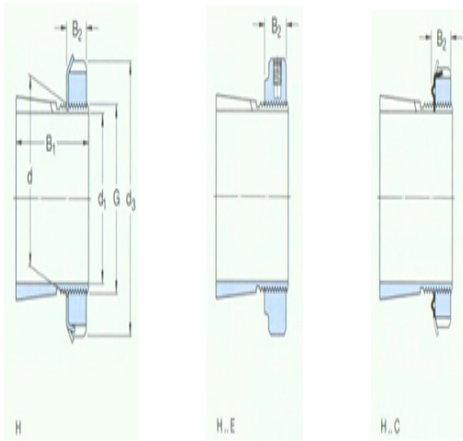

型号: KM15

尺寸

d ₁ :	65
d:	75
d ₃ :	98
B ₁ :	55
B ₂ :	15
G:	M75×2
质量:	0.78



型号

带锁紧螺母和锁定装置的紧定套:	H315
锁紧螺母:	KM15
锁紧装置:	MB15
适用的液压螺母:	HMV15 E