

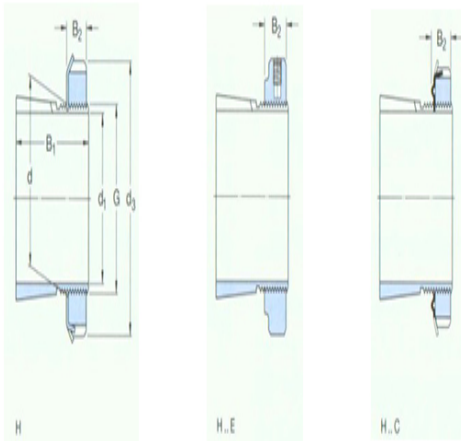

型号: KM16

尺寸

d <sub>1</sub> :	70
d:	80
d <sub>3</sub> :	105
B <sub>1</sub> :	78
B <sub>2</sub> :	17
G:	M80×2
质量:	1.2



型号

带锁紧螺母和锁定装置的紧定套:	H2316
锁紧螺母:	KM16
锁紧装置:	MB16
适用的液压螺母:	HMV16 E