

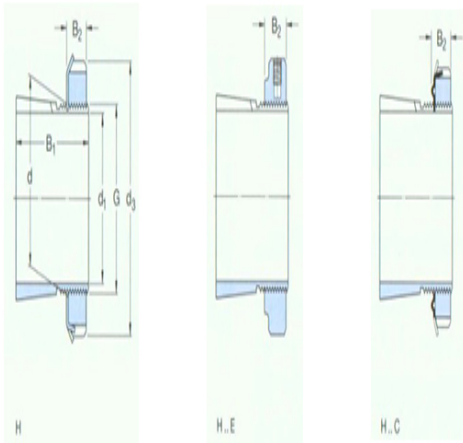

型号: MB8

尺寸

d <sub>1</sub> :	35
d:	40
d <sub>3</sub> :	58
B <sub>1</sub> :	46
B <sub>2</sub> :	10
G:	M40×1.5
质量:	0.22



型号

带锁紧螺母和锁定装置的紧定套:	H2308
锁紧螺母:	KM8
锁紧装置:	MB8
适用的液压螺母:	-