

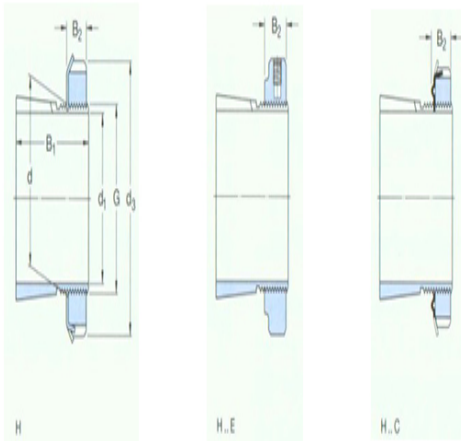

型号: MB12

尺寸

d ₁ :	55
d:	60
d ₃ :	80
B ₁ :	62
B ₂ :	13
G:	M60×2
质量:	0.45



型号

带锁紧螺母和锁定装置的紧定套	H2312
:	
锁紧螺母:	KM12
锁紧装置:	MB12
适用的液压螺母:	HMV12 E