

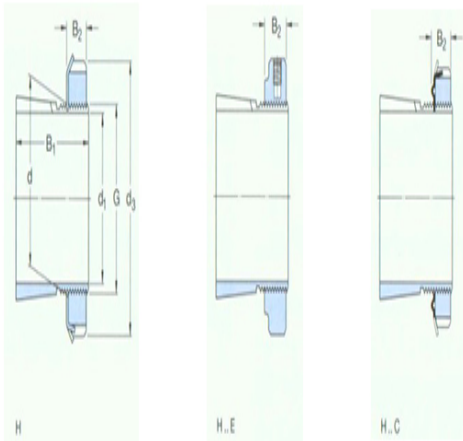

型号: MB13

尺寸

d ₁ :	60
d:	65
d ₃ :	85
B ₁ :	40
B ₂ :	14
G:	M65×2
质量:	0.36



型号

带锁紧螺母和锁定装置的紧定套:	H213
锁紧螺母:	KM13
锁紧装置:	MB13
适用的液压螺母:	HMV13 E