

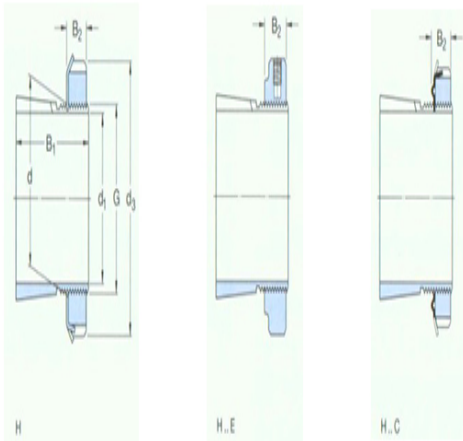

型号: MB14

尺寸

d ₁ :	60
d:	70
d ₃ :	92
B ₁ :	52
B ₂ :	14
G:	M70×2
质量:	0.67



型号

带锁紧螺母和锁定装置的紧定套:	H314
锁紧螺母:	KM14
锁紧装置:	MB14
适用的液压螺母:	HMV14 E