

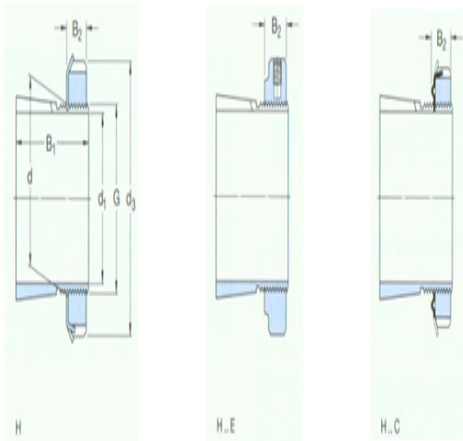

型号: MB16

尺寸

d ₁ :	70
d:	80
d ₃ :	105
B ₁ :	46
B ₂ :	17
G:	M80×2
质量:	0.81



型号

带锁紧螺母和锁定装置的紧定套:	H216
锁紧螺母:	KM16
锁紧装置:	MB16
适用的液压螺母:	HMV16 E