

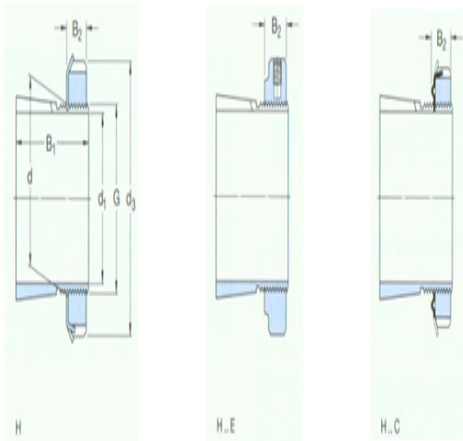

型号: HMV12E

尺寸

d ₁ :	55
d:	60
d ₃ :	80
B ₁ :	47
B ₂ :	14
G:	M60×2
质量:	0.4



型号

带锁紧螺母和锁定装置的紧定套:	H312E
锁紧螺母:	KMFE12
锁紧装置:	-
适用的液压螺母:	HMV12 E