

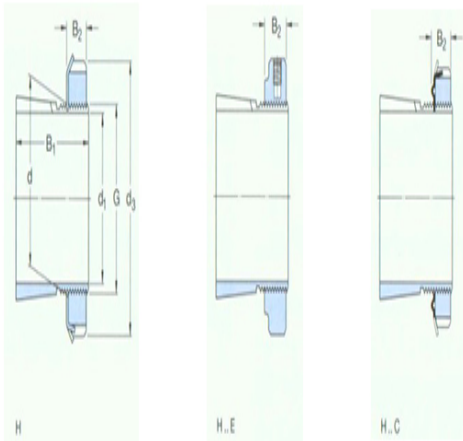

型号: HMV15E

尺寸

d ₁ :	65
d:	75
d ₃ :	98
B ₁ :	43
B ₂ :	15
G:	M75×2
质量:	0.66



型号

带锁紧螺母和锁定装置的紧定套:	H215
锁紧螺母:	KM15
锁紧装置:	MB15
适用的液压螺母:	HMV15 E