

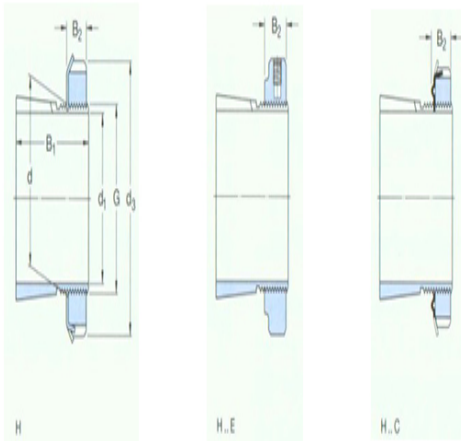

型号: HMV16E

尺寸

d ₁ :	70
d:	80
d ₃ :	105
B ₁ :	78
B ₂ :	17
G:	M80×2
质量:	1.2



型号

带锁紧螺母和锁定装置的紧定套:	H2316
锁紧螺母:	KM16
锁紧装置:	MB16
适用的液压螺母:	HMV16 E