

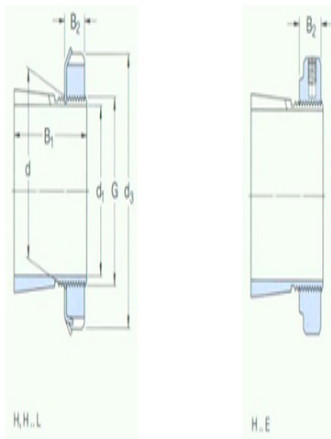

型号: H2318

尺寸

d ₁ :	80
d:	90
d ₃ :	120
B ₁ :	86
B ₂ :	18
G:	M90×2
质量:	1.6



型号

带锁紧螺母和锁定装置的紧定套	H2318
:	
锁紧螺母:	KM18
锁紧装置:	MB18
适用的液压螺母:	HMV18 E