

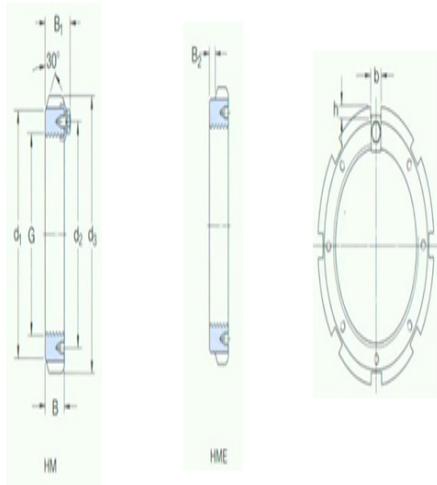

型号: HM3072

尺寸

G:	Tr 360×5
d ₁ :	394
d ₂ :	375
d ₃ :	420
B:	45
B ₁ :	58
B ₂ :	-
b:	28
h:	13
质量:	11.5



型号

不带锁紧定扣的锁紧螺母	HM3072
:	
适用锁紧扣:	MS3072
适用扳手:	TMFN64-80