

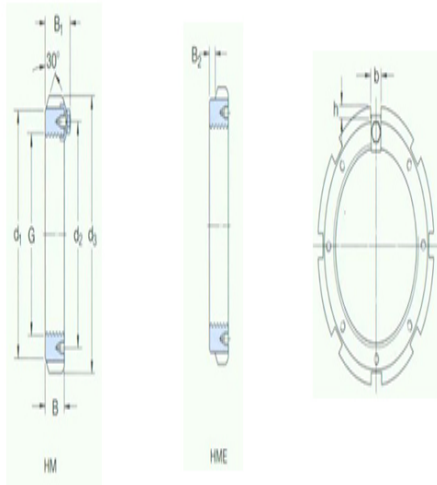

型号: HM31/500

尺寸

G:	Tr 500×5
d ₁ :	580
d ₂ :	540
d ₃ :	630
B:	80
B ₁ :	100
B ₂ :	-
b:	40
h:	23
质量:	63.5



型号

不带锁紧定扣的锁紧螺母	HM31/500
:	
适用锁紧扣:	MS31/500
适用扳手:	TMFN80-500