

型号: HM31/530

尺寸

G:	Tr 530×6
d <sub>1</sub> :	610
d <sub>2</sub> :	575
d <sub>3</sub> :	670
B:	80
B <sub>1</sub> :	105
B <sub>2</sub> :	-
b:	40
h:	23
质量:	71.5

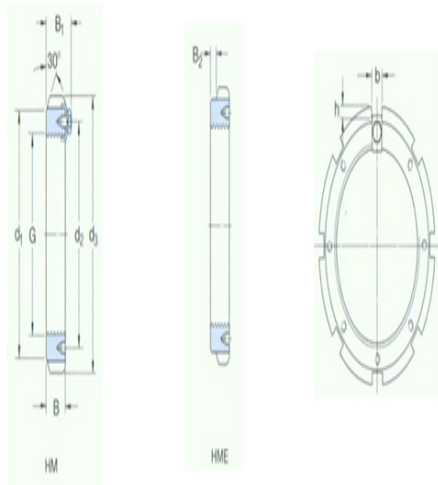

型号

不带锁紧定扣的锁紧螺母	HM31/530
:	
适用锁紧扣:	MS31/530
适用扳手:	TMFN500-600