

型号: HME30/560

尺寸

G:	Tr 560×6
d ₁ :	610
d ₂ :	583
d ₃ :	650
B:	75
B ₁ :	97
B ₂ :	12
b:	40
h:	20
质量:	44.5

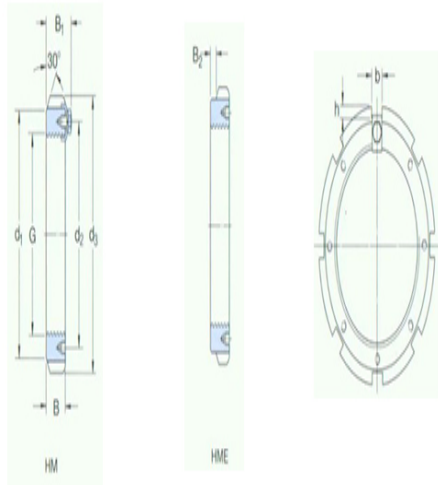

型号

不带锁紧定扣的锁紧螺母	HME30/56
:	0
适用锁紧扣:	MS30/560
适用扳手:	TMFN500-600