

型号: MS3084

尺寸

G:	Tr 420×5
d ₁ :	462
d ₂ :	439
d ₃ :	490
B:	52
B ₁ :	66
B ₂ :	-
b:	32
h:	14
质量:	18.5

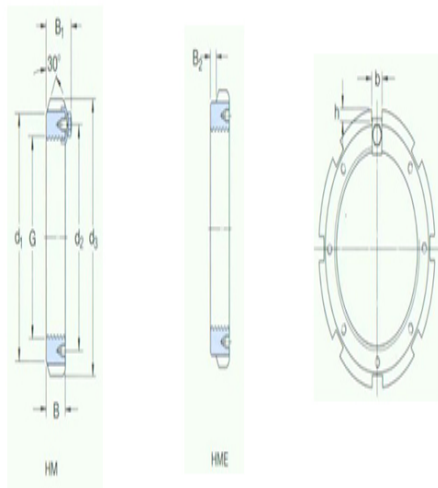

型号

不带锁紧定扣的锁紧螺母	HM3084
:	
适用锁紧扣:	MS3084
适用扳手:	TMFN64-80